

GC4701-6LP Datasheet
RoHS-Compliant Control Devices
DC–15 GHz Surface Mount Limiter PIN Diode



**Microsemi Corporate Headquarters**

One Enterprise, Aliso Viejo,
CA 92656 USA

Within the USA: +1 (800) 713-4113

Outside the USA: +1 (949) 380-6100

Fax: +1 (949) 215-4996

Email: sales.support@microsemi.com

www.microsemi.com

©2016 Microsemi Corporation. All rights reserved. Microsemi and the Microsemi logo are registered trademarks of Microsemi Corporation. All other trademarks and service marks are the property of their respective owners.

Microsemi makes no warranty, representation, or guarantee regarding the information contained herein or the suitability of its products and services for any particular purpose, nor does Microsemi assume any liability whatsoever arising out of the application or use of any product or circuit. The products sold hereunder and any other products sold by Microsemi have been subject to limited testing and should not be used in conjunction with mission-critical equipment or applications. Any performance specifications are believed to be reliable but are not verified, and Buyer must conduct and complete all performance and other testing of the products, alone and together with, or installed in, any end-products. Buyer shall not rely on any data and performance specifications or parameters provided by Microsemi. It is the Buyer's responsibility to independently determine suitability of any products and to test and verify the same. The information provided by Microsemi hereunder is provided "as is, where is" and with all faults, and the entire risk associated with such information is entirely with the Buyer. Microsemi does not grant, explicitly or implicitly, to any party any patent rights, licenses, or any other IP rights, whether with regard to such information itself or anything described by such information. Information provided in this document is proprietary to Microsemi, and Microsemi reserves the right to make any changes to the information in this document or to any products and services at any time without notice.

About Microsemi

Microsemi Corporation (Nasdaq: MSCC) offers a comprehensive portfolio of semiconductor and system solutions for aerospace & defense, communications, data center and industrial markets. Products include high-performance and radiation-hardened analog mixed-signal integrated circuits, FPGAs, SoCs and ASICs; power management products; timing and synchronization devices and precise time solutions, setting the world's standard for time; voice processing devices; RF solutions; discrete components; enterprise storage and communication solutions; security technologies and scalable anti-tamper products; Ethernet solutions; Power-over-Ethernet ICs and midspans; as well as custom design capabilities and services. Microsemi is headquartered in Aliso Viejo, California, and has approximately 4,800 employees globally. Learn more at www.microsemi.com.

1 Revision History

The revision history describes the changes that were implemented in the document. The changes are listed by revision, starting with the most current publication.

1.1 Revision 1.0

Revision 1.0 was the first publication of this document.

Contents

1	Revision History.....	3
1.1	Revision 1.0.....	3
2	Product Overview	7
2.1	Applications	7
2.1.1	Benefits.....	8
2.2	Key Features.....	8
3	Electrical Specifications.....	9
3.1	Absolute Maximum Ratings	9
3.2	Device Electrical Parameters.....	9
3.3	Typical RF Performance.....	9
4	Small Signal Measurements	10
5	Transfer Characteristics.....	11
6	Package Outline.....	12
7	Evaluation Board Assembly.....	13
8	Tape-and-Reel Format.....	14
9	Ordering Information	15

List of Figures

Figure 1 Functional Block Diagram	7
Figure 2 Insertion Loss	10
Figure 3 Input Return Loss	10
Figure 4 Typical Limiter Performance	11
Figure 5 Functional Block Diagram	12
Figure 6 Package Dimensions	12
Figure 7 Package Outline	12
Figure 8 Evaluation Board Assembly.....	13
Figure 9 Tape-and-Reel Format	14

List of Tables

Table 1 Absolute Maximum Ratings	9
Table 2 Device Electrical Parameters	9
Table 3 Typical RF Performance.....	9
Table 4 Ordering Information	15

2 Product Overview

The GC4701-6LP SMT PIN limiter element is a specially processed PIN diode packaged in a convenient, low-cost plastic outline suitable for standard or co-planar microstrip circuits. Featuring low-loss, low turn-on, and high self-biased isolation, this device is designed for use in passive or active limiters at frequencies through X-band.

This surface mount limiter meets RoHS requirements according to EU directives 2011/65/EC and 2002/95 EC.

The following illustration shows the primary functional blocks of the GC4701-6LP device.

Figure 1 Functional Block Diagram

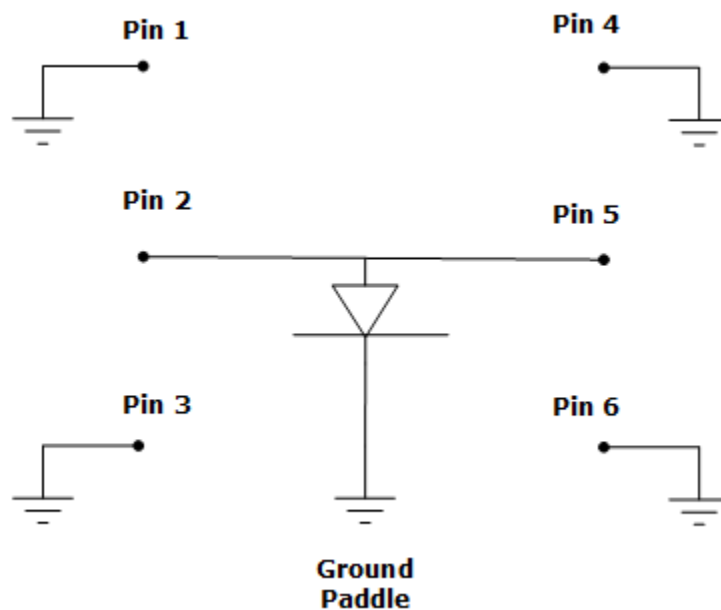

2.1 Applications

A diode limiter is a power-sensitive variable attenuator that uses the non-linear properties of the diode to provide an impedance mismatch when sufficient amounts of RF power are incident on the device. The output power is reduced to a level that will not overdrive a receiver, burn out a mixer, or otherwise compromise the device. For varying input power levels in excess of the diode's threshold level, the limiter's output power tends to remain constant.

A passive limiter is one in which the limiter diodes are turned on by the RF signal itself. An active limiter is one in which the limiter diodes are turned on primarily by an external bias current typically supplied by a Schottky detector diode that senses the incident signal.

Since limiter diodes are not designed to dissipate large amounts of power, the limiter must reflect or divert the excess incident power back to the source or to another load (through a circulator or a hybrid coupler, for example).

Limiter diodes may be used in wave guides, coax, microstrip, stripline, or other media. Single or cascaded devices may be used, depending on power levels.

2.1.1 Benefits

The GC4701-6LP device provides the following application benefits:

- Receiver protection circuits
- Amplifier protection

2.2 Key Features

The following are key features of the GC4701-6LP device:

- Low insertion loss: 0.1 dB
- Designed for applications to 15 GHz
- 50 dBm peak and 34.8 dBm CW power
- Excellent flat leakage: 22 dBm
- Low-P1dB compression point: 10 dBm
- Gold-doped for fast turn-on
- Lead-free 1.6mm × 1.6 mm 6-lead plastic QFN package
- RoHS compliant

3 Electrical Specifications

3.1 Absolute Maximum Ratings

The following table shows the absolute maximum ratings at 25 °C unless otherwise specified.

Table 1 Absolute Maximum Ratings

Rating	Symbol	Value	Unit
Maximum leakage current (at 80% of minimum-rated V_B)	I_R	0.5	μA
Forward voltage drop	V_F	1.2 at $I_F = 10 \text{ mA}$	V
Operating temperature	T_{OP}	–55 to 150	°C
Storage temperature	T_{STG}	–65 to 150	°C
ESD sensitivity (HBM)		Class 1A	
Moisture sensitivity level		MSL 1	

3.2 Device Electrical Parameters

The following table shows the device electrical parameters at 25 °C where the pulse length is 1 μs .

Table 2 Device Electrical Parameters

Model Number	V_b $I_R = 10 \mu\text{A}$ (Min)	C_{t0} at 0 V (Typ)	C_{t-6} at 6 V (Max)	R_s at 10 mA (Typ)	T_L (Typ)	θ_P^1 Thermal Resistance (Typ)	θ_P Thermal Resistance (Max)
GC4701-6LP	20 V	0.35 pF	0.25 pF	1.5 Ω	10 ns	20 °C/W	50 °C/W

1. Pulse length is 1 μs

3.3 Typical RF Performance

The following table shows the typical RF performance at 25 °C.

Table 3 Typical RF Performance

Model Number	V_b (Min)	Peak Power P_{IN} at 1 μs Duty cycle 0.1%	Typical Leakage P_{OUT}	Typical Threshold P_{1dB}	Typical INS. Loss I_L	Maximum CW Power
GC4701	20	50 dBm	22 dBm	10 dBm	0.1 dB	3 W

4 Small Signal Measurements

The following graphs show the small signal measurement curves of the GC4701-6LP device.

Figure 2 Insertion Loss

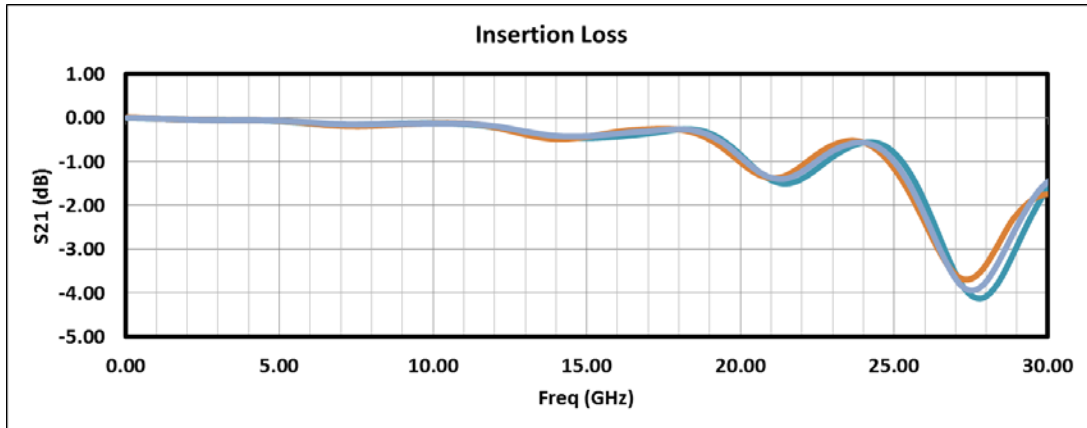
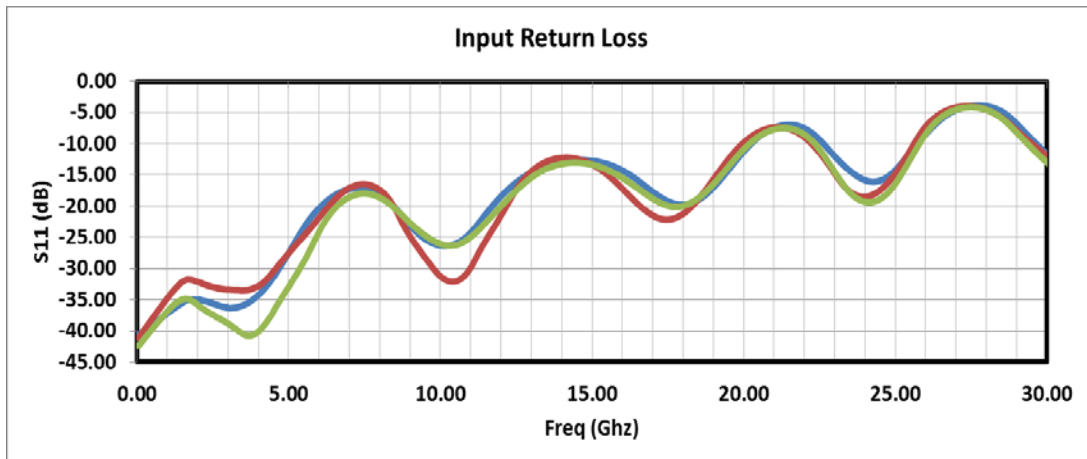

Figure 3 Input Return Loss



5 Transfer Characteristics

The following graph shows the transfer characteristics of the GC4701-6LP device.

Figure 4 Typical Limiter Performance

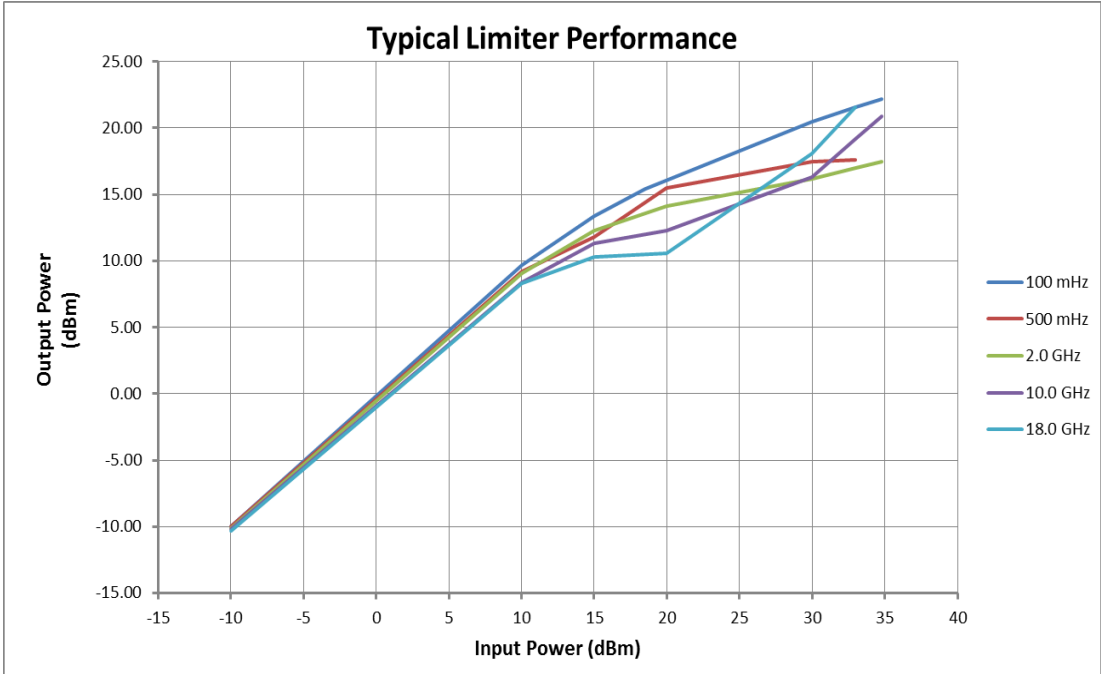

6 Package Outline

The following illustration shows the package outline of the GC4701-6LP device. Units are in millimeters.

Figure 5 Functional Block Diagram

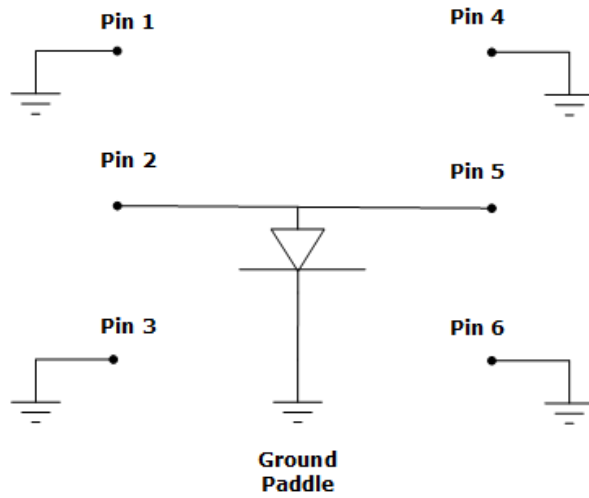

Figure 6 Package Dimensions

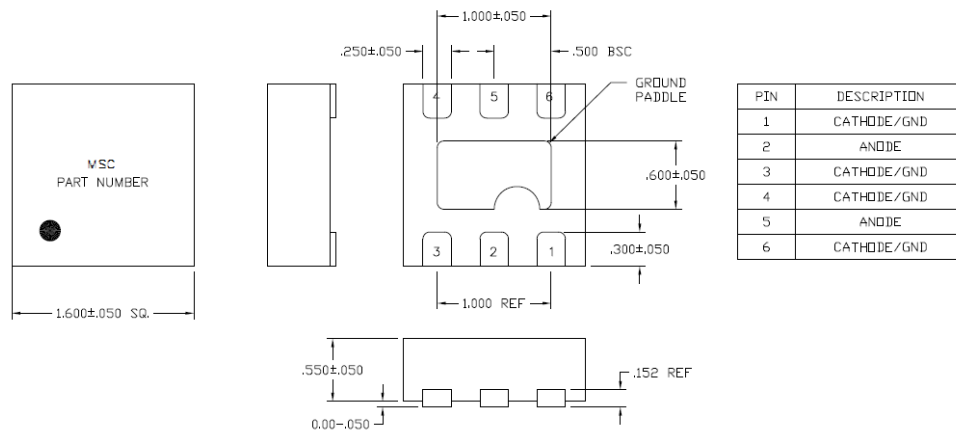
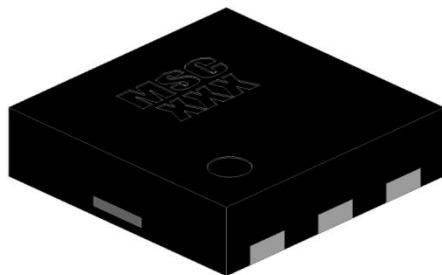

Figure 7 Package Outline



7 Evaluation Board Assembly

The following illustrations show the evaluation board assembly of the GC4701-6LP device (ordering part number: MSTF0012). The board material is 0.016 Rogers 4003, 0.5 oz. copper cladding on both sides (starting thickness). It has a full-metal backside and an electroless nickel immersion gold (ENIG) finish on both sides. Solder mask is applied to the topside only. Units are in inches.

Figure 8 Evaluation Board Assembly

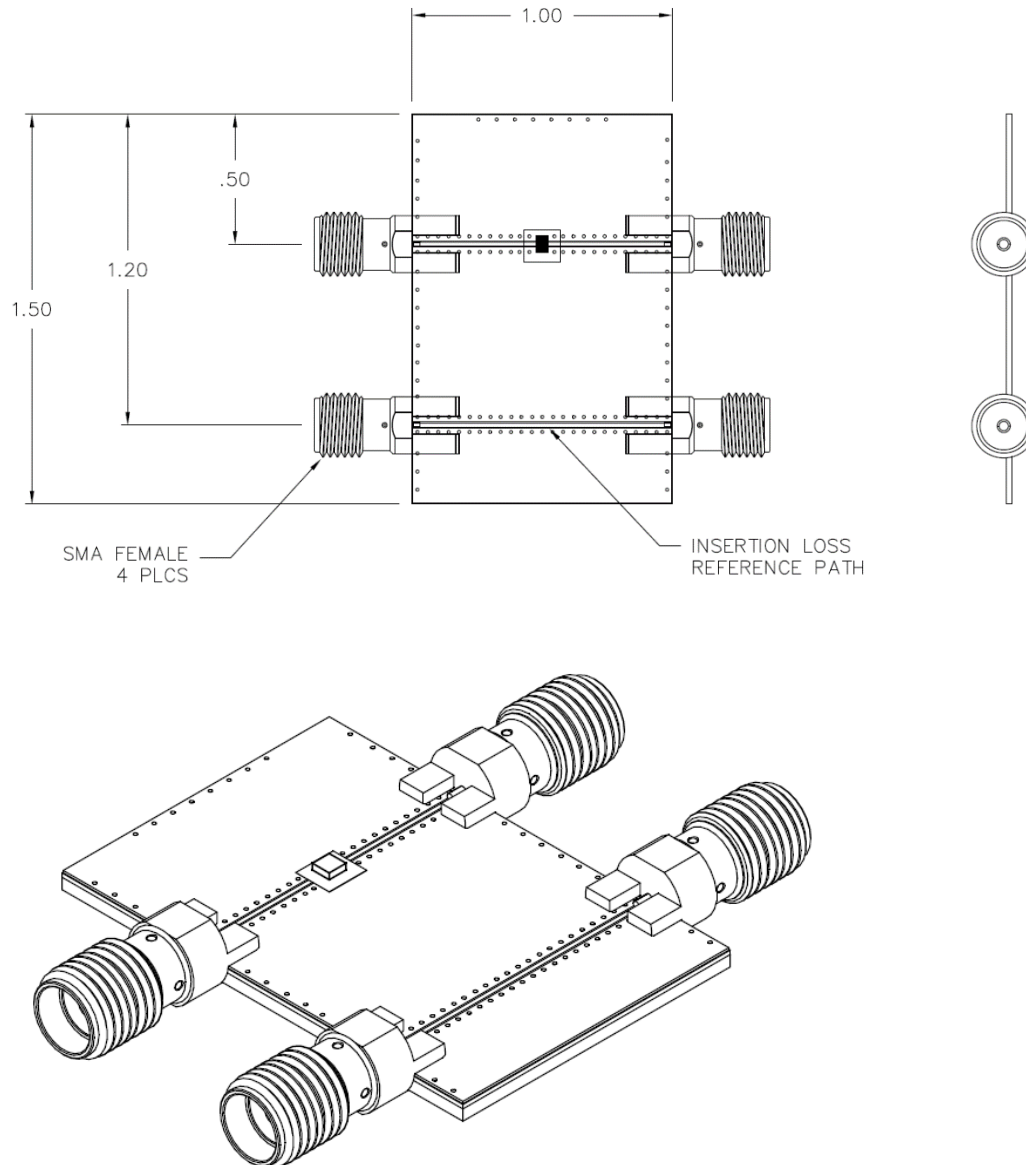

8 Tape-and-Reel Format

The following illustration shows the tape-and-reel format of the GC4701-6LP device.

Figure 9 Tape-and-Reel Format

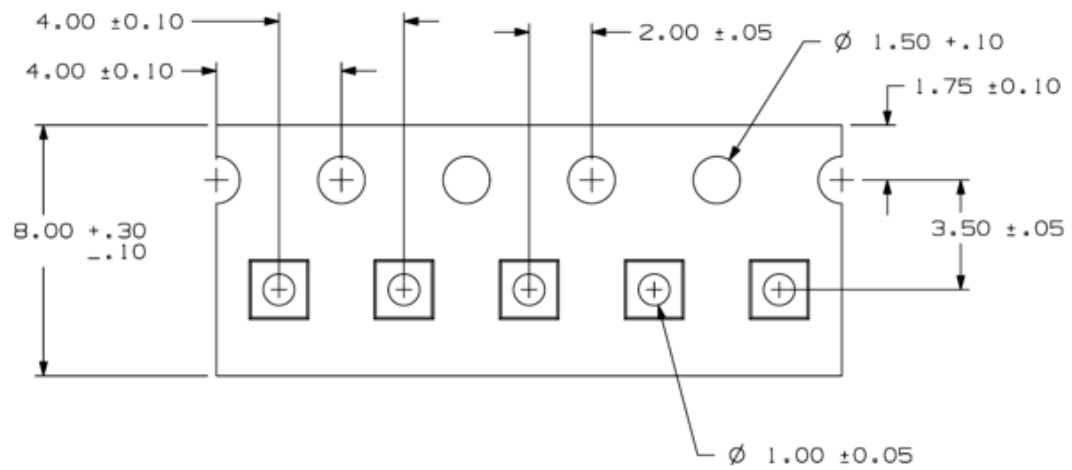

9 Ordering Information

The following table shows the ordering information for the GC4701-6LP device.

Table 4 Ordering Information

Part Number	Package
GC4701-6LP	Plastic QFN
MSTF0012	Evaluation board assembly